

2 LEFT ELEVATION

SCALE: 1:100

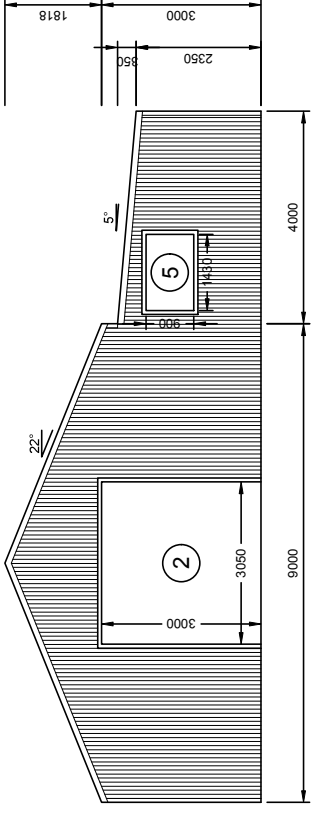

3 REAR ELEVATION

SCALE: 1:100



FRAME #5

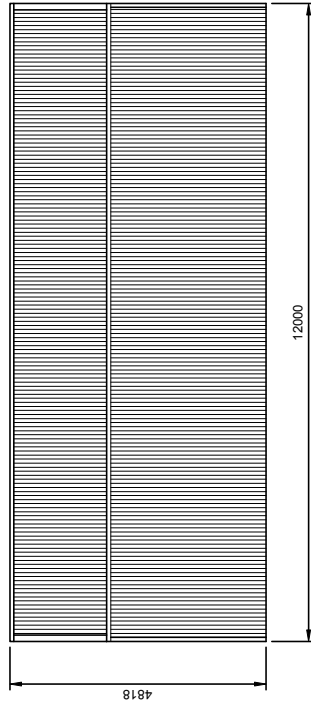

1 RIGHT ELEVATION

SCALE: 1:100

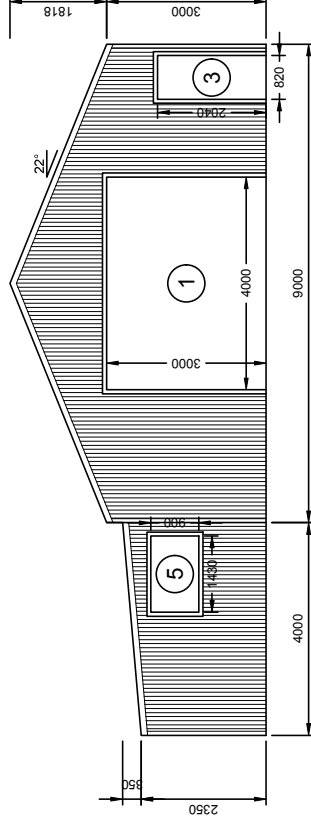

4 FRONT ELEVATION

SCALE: 1:100



FRAME #1

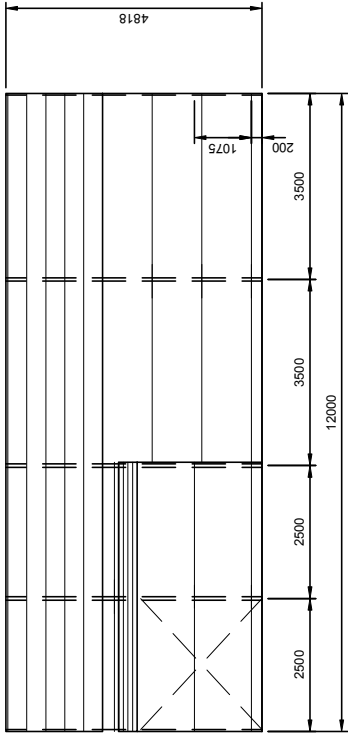

2 LEFT ELEVATION

SCALE: 1:100

3

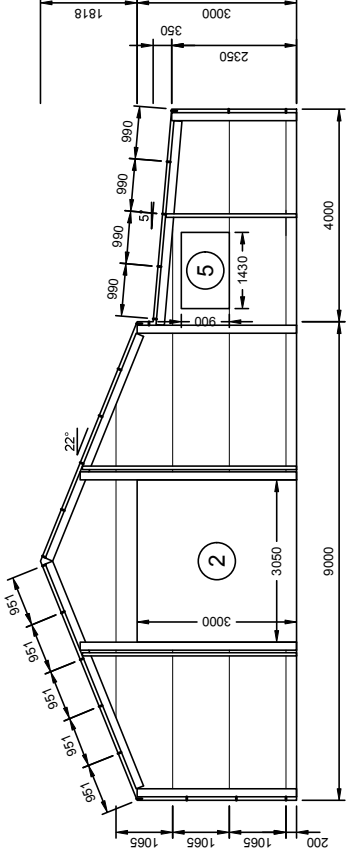

3 REAR ELEVATION

SCALE: 1:100

3

FRAME #5

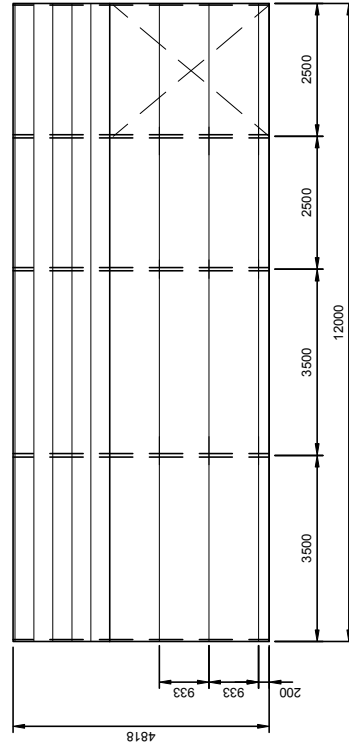

1 RIGHT ELEVATION

SCALE: 1:100

3

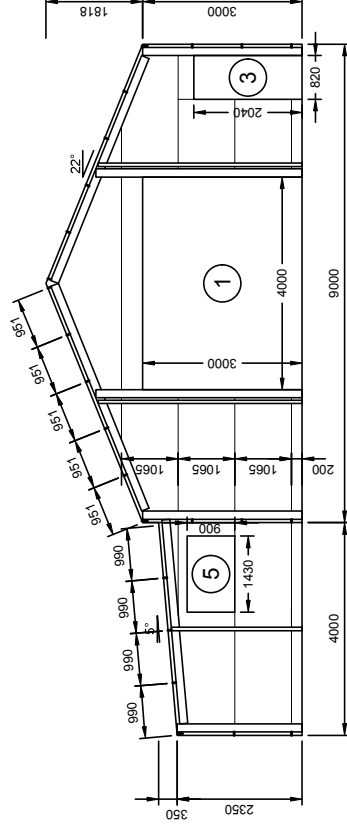

4 FRONT ELEVATION

SCALE: 1:100

3

FRAME #1

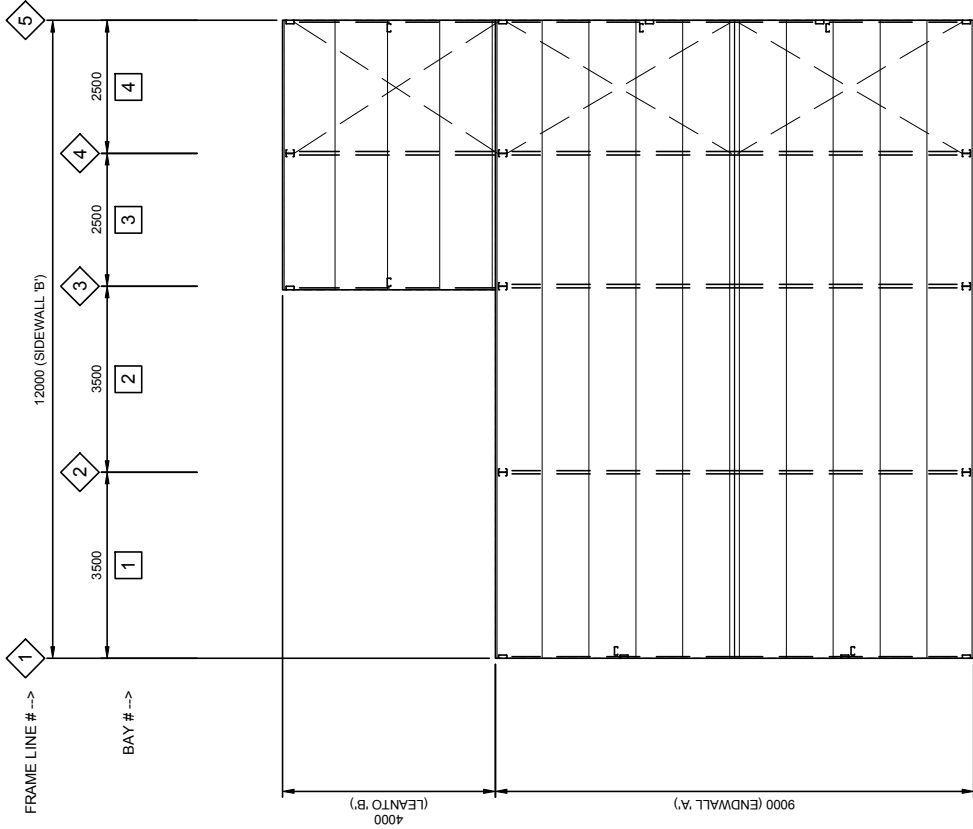

2 ROOF FRAMING PLAN
SCALE: 1:100

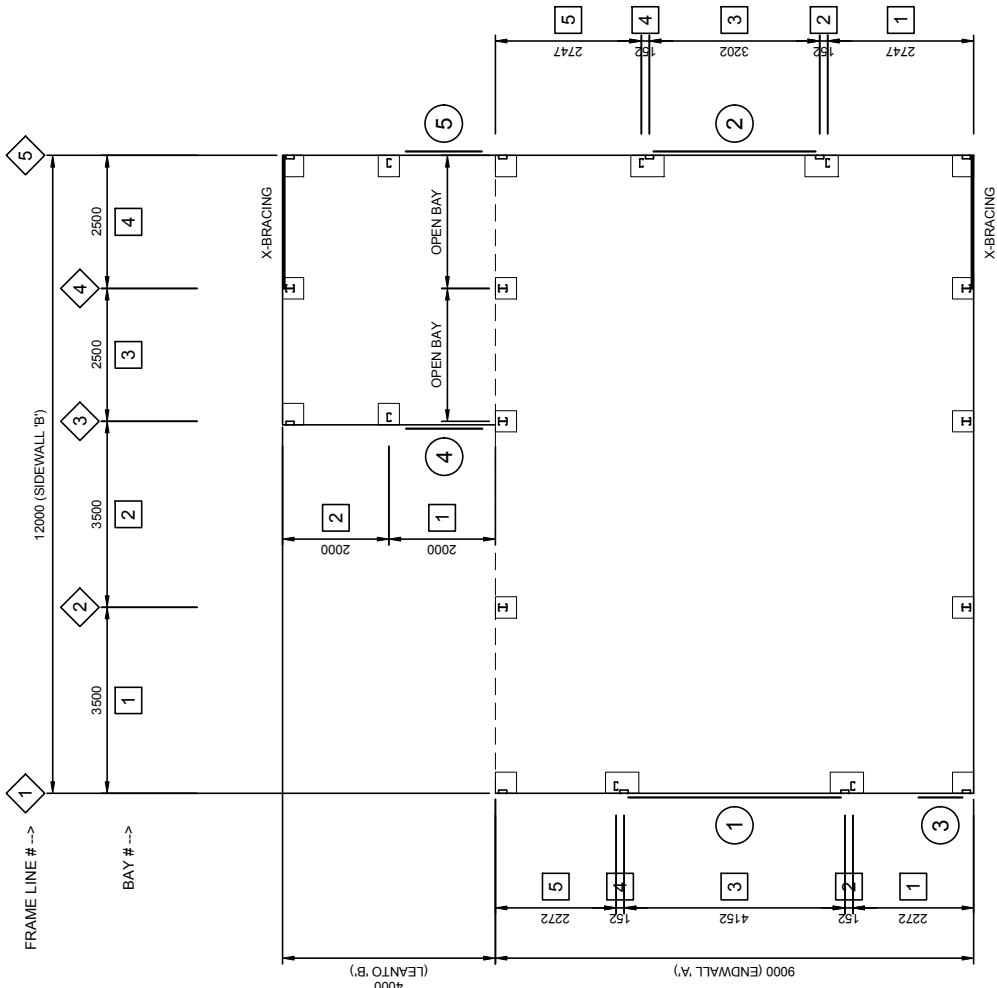

1 FLOOR PLAN
SCALE: 1:100



Value & Quality Direct to You

151 Smeaton Grange Road,
Smeaton Grange, NSW, 2567.
Phone: 02 4648 7777
Fax: 02 4648 7700
Email: sales@bestsheds.com.au

DATE 28-06-2022
JOB NO. 1614387053
SHEET 4 of 7

CIVIL & STRUCTURAL ENGINEERS
COMMERCIAL - INDUSTRIAL - RESIDENTIAL - FORENSIC - STEEL DETAILING
CAMILO PINEDA MORENO
PROFESSIONAL ENGINEER
REG. NO. 15546 TSP P6008976 (VIC)

Customer Name: Adam Fauli
Site Address: 22-24 WEDGE TAIL CT
MOUNT COTTON,
QLD, 4165

Date: 28.06.2022

Signature: 

2 / 4

SCALE: 1:100